



Hello

We have designed CheckBox Wireless Systems™ to be easy to install, easier to manage and easiest to afford. For best results, before beginning to set up your system, please take the time to read through this booklet completely. The answer to most questions can be found in here.

We are constantly working on adding new features to CheckBox, and as these features develop they will be added to your system automatically via system updates. These updates may change the way some of your administration screens appear and how features function. To keep current on these new features you can download an updated version of this booklet at www.CheckBoxSystems.net

Thank you for purchasing a CheckBox System!

Table of Contents

| | |
|--|------------|
| Installing CheckBox..... | 3 |
| Logging into your management screens..... | 5 |
| Network setup..... | 6 |
| Setting Up & Using MultiNet..... | 7 |
| Setting up guest access..... | 10 |
| Using credit cards & PayPal..... | 11 |
| Free access..... | 12 |
| PermaCode..... | 13 |
| Room Prompt setup..... | 13 |
| Customizing your welcome screen..... | 14 |
| Accessing your system from outside the hotspot..... | 16 |
| Administering active clients..... | 19 |
| Client Usage Policy..... | 20 |
| Network Statistics..... | 21 |
| Signal strength, power levels and antennas..... | 22 |
| Mesh repeaters and the mesh node status display..... | 23 |
| Final Installation Checklist..... | 25 |
| CheckBox S/A/F/E - The Survey and Feedback Engine..... | 26 |
| Setting up CheckBox S/A/F/E..... | 27 |
| Receiving & Responding to Messages w/S/A/F/E..... | 30 |
| Creating Guest Surveys with S/A/F/E..... | 31 |
| S/A/F/E Guest Contact Information..... | 34 |
| System Alerts..... | 33 |
| Included Optional Services..... | 34 |
| Privacy Policies and disclosures..... | 35 |
| Warranty Information..... | Back Cover |

Installing CheckBox

The best way to connect your CheckBox System is directly to your DSL, fiber, satellite, or cable modem. It can also be connected through a switch or dedicated firewall system, which may require some configuration on your switch or firewall.

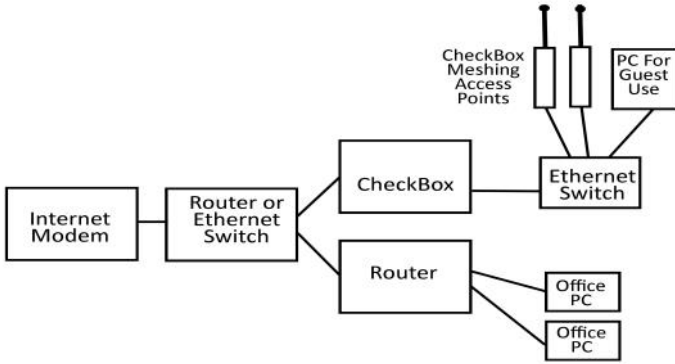

You may also use an Ethernet switch attached to your CheckBox to connect multiple CheckBox Meshing Access Points. You can also connect a wired PC for guests to use to this switch. When connecting multiple access points or guest PCs to the CheckBox be sure to use an Ethernet switch and not a router—routers plugged into the guest network after CheckBox will cause issues with guests being properly authenticated and managed.

Please note - If you are using the private administrative network then any device plugged into the CheckBox will be on the private network and not on a guest network.

An Important note on surge protection

Your CheckBox controller and access points are built to exceed industry standards to withstand power surges caused by electrical fluctuations. Large surges caused by power spikes from the power company, other devices sharing the power circuit or nearby lightning strikes can damage any electronic device, including your CheckBox controller or access points. This damage could cause immediate or delayed failure.

To reduce the risk of damage your CheckBox controller should be connected to an outlet that is not shared by devices that have high start up current demands (such as air conditioners, coolers, or any device with a large motor) and protected by a good quality surge protector. If you regularly experience power glitches or power failures you should use a UPS (Uninterruptible Power Supply) for additional protection. Your modem, switches and firewall devices should all be on the same surge protector and UPS.



Power spikes, particularly spikes from nearby lightning strikes, can also spread through your system through long runs of Ethernet cables that run outside. For long outdoor cable runs, or cable runs between building use fiber optic cables instead of Ethernet cables. Fiber optic cables will not transmit power spikes and provide an effective barrier to contain potential damage from power spikes and lightning strikes.

Locating the equipment

The CheckBox HSv430 must be located indoors in a dry area. The HSv430 should be located close to power and the Internet connection.

Connecting the equipment

The CheckBox HSv430 will connect to your DSL, fiber, satellite, or cable modem using an Ethernet network cable. Connect one end of a cable to the port marked **Internet** on the CheckBox and the other end to your Internet connection. Depending upon your particular modem the jack may be marked "LAN", "PC", "Host" or something else.

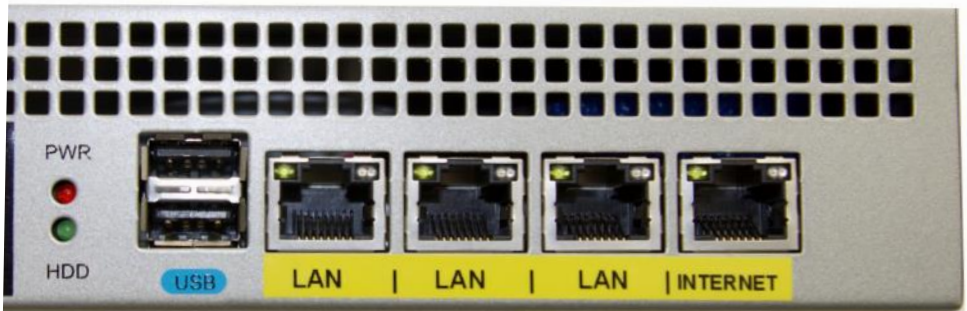

The ports marked **LAN** will connect to your CheckBox access points and wired devices such as computers, point-of-sale systems, security cameras etc. These devices may connect directly through the CheckBox or through Ethernet switches.

CheckBox Access points receive power and data through the same cable (known as power-over-Ethernet or PoE). Make sure you use the PoE adapter included with your CheckBox access points or appropriate PoE switches when connecting your CheckBox access points to your controller.

Guest traffic should not be connected through other routers before being connected to CheckBox. Routers connected between the guests and the CheckBox will cause failure to identify individual devices on the network and failure to authenticate users properly.

The jack marked **Power** connects to the included AC power adapter.

Logging into your Administration Screens

The administration screens are used to manage your system, create and print tickets for your users and view your system status. The administration screens also allow you to view users on the system (Active Clients), view tickets not yet used, and to delete tickets from the system. These screens are accessed through a web browser on your computer, and can be accessed from inside the hotspot or from outside the hotspot from anywhere on the internet. To learn how to access the system from outside the hotspot see **Accessing Your System from the Internet** section in this guide.

To access CheckBox from inside the hotspot make sure your computer is connected to the system, *either by a wireless connection or through a wired Ethernet port connected to the CheckBox*. If you are connecting wirelessly select the wireless network "hotspot", the default name for the CheckBox wireless network. You can change this name later.

Open your web browser and you should see a generic welcome screen.



Internet Access Available

Use of this service constitutes agreement with the Terms of Service listed below.
If you do not agree with the Terms of Service you may not use this service.

Use of this service shall be for lawful purposes only. This service is designed primarily for web browsing and email. Users consuming excessive bandwidth will be automatically subjected to reduced speeds. Abuse of this service may result in termination of access without warning or refund, and cause the user to be barred from future access.

This will bring up a page warning you that no password has yet been set for the administration screens for your CheckBox. Create a password that is a combination of letters and numbers.

Do not use any spaces or special characters (such as **&**, *****, **@**, **!**)

Enter your chosen password twice and press **Set Password**. A box will pop up so that you can test your password. If your are asked for a user name, leave the user name box empty.

This is the welcome screen your guests will see when they first log on to your hotspot (you can customize this screen - see page 14). From here your guests are prompted to enter a ticket number, credit card or any of the access methods that you have enabled before they can connect to the internet. Of course you do not have tickets since you have not yet created them! To access the administration screens enter the following in the address bar (NOT your search box):

<http://192.168.17.1:3456/admin>



Administration | Access Controls | Customize Site | Network Setup | Mesh

Access Control

Operator Password

Retype Password

Network Setup

You probably will not need to make any changes in the network setup of your CheckBox system as most Internet Service Providers use DHCP, Dynamic Host Configuration Protocol, to tell the devices connected to their network what address and other parameters to use.



The screenshot shows the 'Internet Access Setup' section of the CheckBox Systems interface. It includes a navigation menu with 'Administration', 'Access Controls', 'Customize Site', 'Network Setup', and 'Mesh'. The 'Internet Access Setup' section has a radio button for 'Automatic (DHCP)' which is selected, and a 'Fixed' option. Below this, there are input fields for 'Adapter Name', 'IP Address', 'Netmask', 'Gateway', and 'DNS', along with an 'Update' button.

If your Internet Service Provider uses static IP addresses, or if you are connecting CheckBox to an internal company network you may need to set some network parameters manually.

To enter Network Setup click on **Network Setup** on the top menu and then **Internet** in the drop down menu. The Network Setup page will appear.

In the Network Setup page you will see a summary of the Internet connection currently connected to each of the ports on your CheckBox.

If the Internet connection is set for DHCP (automatic configuration) the IP address received via DHCP will be displayed here.

If you need to set a fixed (static or permanent IP address) click on **Fixed** and then enter the IP address, Netmask, Gateway and DNS information in the appropriate boxes. Click Update and then restart your system.

The **Network Setup** page will show you the recent data rates (speed) and maximum data rate on the Internet connection. You can test the Internet connection by pressing clicking the Link Speed Test button. The test will take from 20 to 60 seconds to complete.



The screenshot shows the 'Current Internet Configuration' page. It features the CheckBox Systems logo and navigation menu. Below the title, there is a table for 'Internet Port' with columns for Mac, Ethernet, Duplex, Ip, Netmask, Gateway, Recent Data Rate, Maximum Data Rate, Recent Uplink Rate, and Maximum Uplink Rate. At the bottom, there are buttons for 'Setup', 'Link Speed Test', and a 'Port Speed Color Codes' legend showing 'Gigabit', '100mbit', '10mbit', and 'Unplugged'.

Local Address

Local Address refers to the IP addresses the CheckBox system assigns to users on the system. By default this address is in the 192.168.17.xxx range. This setting should not be changed under most circumstances. If there is a need to change this address range, select **Network Setup** on the top menu and then **Local** from the drop down menu and enter the new address range in here and press update.

NEVER SET THE LOCAL ADDRESS RANGE TO BE THE SAME AS THE ADDRESS RANGE OF THE INTERNET CONNECTION. This will cause routing errors and you will lose contact with the unit.



The screenshot shows the 'Local Address' setup page. It includes the CheckBox Systems logo and navigation menu. The 'Local Address' section has an input field for 'IP Address' with the value '192.168.17.1' and an 'Override DNS' checkbox. Below this are sections for 'Local Port Status' (showing ports 1 and 2), 'Port Color Codes' (Gigabit, 100mbit, 10mbit, Unplugged), and 'Network IP Ranges' (MeshNodes, Guest Network 1).

This setting rarely needs to change. It will adjust the Local IP address of the master unit, and the IP address range issued to your client's computers. The above address must end with xxx.xxx.xxx.1 for proper operation of your hotspot.

You may override the default DNS used for client/guest lookups. This allows you to specify a local or special DNS that has additional or restricted DNS names.

Note: The Local IP address and the Internet IP address are separate addresses and must be different.

Setting Up & Using MultiNet

MultiNet provides up to two independent guest Wi-Fi networks and one encrypted management network all with one CheckBox System.

With MultiNet you can

- Create a basic and a premium guest network, one free and one paid, with different bandwidth limits.
- Create guest networks with different branding and different welcome pages, such as one for the entire property and one for a restaurant on the property.
- Provide a third, private network that is encrypted for property management and staff to use.

With MultiNet each access point can broadcast multiple networks simultaneously.

To Setup an additional network using MultiNet go to :

Network Setup -> Wireless MultiNet. Here you will see a sub menu:

By default only Guest Network 1 is enabled. Here you disable or enable the network, change the SSID (the name the network broadcasts to devices, and choose Client Isolation and P2P

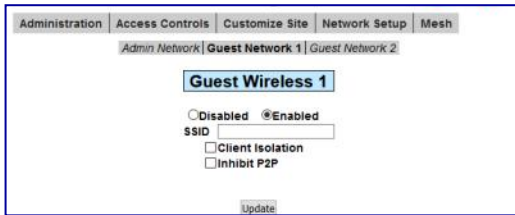

Inhibit options. After making changes press **Update**. Changes may take a few moments to take effect, and if you are connected to the CheckBox wirelessly your connection may be dropped.

Guest Network 2

If you would like to enable a second guest network select Guest Network 2 from the gray menu bar.

You will not be able to set the options for Guest Network 2 until you select Enabled.

After enabling the second guest network, set your SSID and choose Client Isolation and P2P Inhibiting options if appropriate. *The SSID must be different than the SSID used for your first guest network or your admin network.*



Select **Update**. And Wait.

Adding an additional network can take several minutes as the system has to set up the network routes, login screens and update the access points.

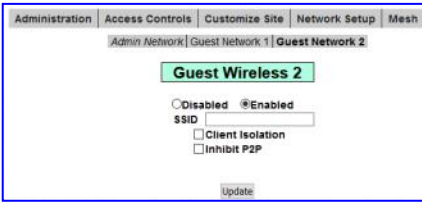

Your second guest network will have it's own welcome page, separate graphics and branding and it's own set of rules and tickets and PermaCodes. You can set up the welcome page and other options under **Customize Site** and **Access Controls**

Admin Network

With CheckBox MultiNet you can add a third, private network for management use. This network doesn't use tickets or PermaCodes like the guest network, instead it uses an encryption key and is secured with WPA2 encryption.

If you would like to enable the Admin Network select Admin Network from the gray menu bar.

You will not be able to set the options for the Admin Network until you select **Enabled**.



After enabling the Admin Network, set your SSID and WPA2 key. *The SSID must be different than the SSID used for your guest network(s) or your admin network. A WPA2 key is required to set up the Admin Network.*

The WPA key is a private key or password used by devices connecting to the admin network. This key should never be shared with guests and only shared with employees that need it to set up and manage devices on the Admin Network. The WPA key can be any string of numbers and letters you choose, but can not include spaces or symbols. It must be at least 8 characters long and can be as long as 63 characters. The longer the string the more secure the key is.

After entering your WPA2 key select **Update**. And Wait.

Adding an additional network can take several minutes as the system has to set up the network routes and update the access points. Changes make take a few moments to take effect, and if you are connected to the CheckBox wirelessly your connection may be dropped.

When only Guest networks are enabled the LAN ports on the CheckBox controller will connect any wired device (PCs, point-of-sale, cameras, etc.) to Guest Network 1. When you enable the Admin network any device wired to the CheckBox controller will be connected to the Admin network. Devices connected wirelessly through a CheckBox access point will be connected to the network associated with it's SSID (Guest 1, Guest 2, or Admin) and routed according to the rules set up for that network.

Wireless

The CheckBox can host CheckBox mesh node access points in wired and wireless modes. At least one CheckBox meshing access point must be wired into the CheckBox for wireless operation.

The SSID is the Service Set Identification - the name of a wireless network that is broadcast to announce the networks presence.

When using CheckBox mesh node access points the ssid and channel of the access points is set and controlled from within the management screens of the CheckBox. If you are using other brands of access points you will need to manage channel changes and SSID as per their manufacturer's directions.

Please note, MultiNet will not work with third-party access points.

By default the ssid is "hotspot". To change the ssid select **Network Setup** from the top menu and then **Wireless** from the drop down menu. Enter the new name and press update. It is important that your name contain only letters and numbers - no spaces or symbols.

Important: If you are using access points connected wirelessly to your system allow 10 minutes after pressing update for the wireless access points to reconfigure their SSID. During this period Do Not make any other system changes (i.e. Local Address or channel) or you run the risk of the access points becoming lost.

By default CheckBox is set to channels 6 and 149. Different networks can co-exist on the same channel in the same area, however if you are running another network or there are other networks in your area you may wish to choose a different channel. To change the channel from the **Mesh** -> **Mesh Nodes** screen click on the access point unit then select the channel(s) from the drop down box and press update.

In some case you may not be able to select channel options for units that are wirelessly connected back to the system, as their channel choice will be controlled by their upstream access point.

Important: If you are using mesh repeaters allow 10 minutes after update for the mesh repeaters to reconfigure their channel. During this period Do Not make any other system changes (i.e. Local Address or SSID) or you run the risk of the repeaters becoming lost.

Network Throughput Test

You can test the speed of the connection between devices on your property and the CheckBox controller by connecting to your admin page with a phone, tablet or laptop via WiFi and then going to **Network Setup** -> **Network Test**.

This will test the connection from your WiFi device (phone/tablet etc.) through your access points and to the CheckBox controller. Test results will be affected by factors including other users, interference and the Client Usage Policy. This will help you determine the kind of system performance your guests can expect.

| Download | Upload |
|---------------|---------------|
| 48.28 Mbps | 20.03 Mbps |

Start

- * This test does **NOT** measure your internet connection.
- * This test measures the bandwidth between your device and the CheckBox controller.
- * This test is meant to help identify areas on the property with poor wifi reception.

Setting up Guest Access

In order for guests to access the Internet through your CheckBox System they have to be authenticated. There are several ways your guests can authenticate, including:

Access Tickets

PermaCodes

Credit Cards and PayPal

Free Access

Third Party Systems such as reservation or point-of-sale.*

*Your CheckBox can also be tied to your company loyalty card rewards program and integrated into point-of-sale systems. For more information on integrating CheckBox with loyalty programs and point-of-sale systems please contact CheckBox Support.

The system will automatically generate the appropriate buttons and boxes on your welcome screen; If you have not printed any tickets and have enabled free access and credit cards, then the system will not display a box to enter access tickets. If you have not enabled credit card payments or free access and have created tickets then only the ticket box will be displayed on your welcome screen. If you have not enabled free access or printed tickets and have enabled credit cards then only the credit card buttons will be displayed.

Access Tickets allow you to create and distribute tickets for your guests that allow them an amount of time online that you determine. These tickets can be good for an amount of time ranging from 15 minutes to one year. You can give these tickets away or sell them.



Tickets can only be used by one device and guest can not share tickets or re-use them.

To create tickets click on **Access Controls** on the menu at the top. Select the duration of the tickets you wish to generate and their expiry date (shelf life) and then click on the **Generate Tickets** button.

A new window will open with a sheet of ten tickets that you can print on a standard printer. The sheet can be cut up, or you can use standard business card stock (Avery 5870 or equivalent) and the tickets will print on the cards.

If you do not see the window of tickets open after selecting **Generate Tickets** be sure that you have pop up blockers disabled or that you allow pop ups from the site.

The Graphic on the ticket can be changed under **Customize Site**.

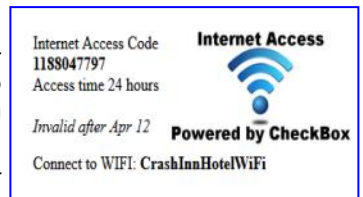

With CheckBox you can accept credit cards automatically through the welcome page. CheckBox uses the PayPal system to clear the transactions and deposit the funds into your account, and allows you to set the pricing and duration. Using credit cards you do not need to be present to hand out tickets - great for unattended locations such as

Using Credit Cards & PayPal

marinas and public spaces.

To accept credit cards and PayPal you will need a [Business Account](#) with PayPal if you do not already have one. Go to www.paypal.com to setup an account. (If you have an existing personal account you can upgrade to a business account). *Make Sure you specify a Business Account when setting up your PayPal Account*

After your PayPal Business account setup has been completed you will need to log in to your PayPal account and set up the following options:

On your PayPal Account Page go to Account Settings, found by clicking on your account name on the top right hand corner, then to Website Payments and then update Website Preferences. In Website Payment Preferences select the following options:

Auto Return: *On*

Return URL: *http://192.168.17.1:3456/paypalreturn*

Payment Data Transfer (optional): *On*

Encrypted Website Payment: *Off*

PayPal Account Optional: *On*

Contact Telephone Number: *Off*

Express Checkout Settings: *No*

Press Save and then go back up to Payment Data Transfer (optional) and you will now have an Identity Token. ***It is very important that you copy this token carefully (using copy & paste) in the next step. We strongly suggest that you copy this token into a blank document to store for safekeeping.***

Once you have completed setting up your PayPal account and have copied your identity token, open the administration page on your CheckBox System and go to **Access Controls** on the top menu and then **PayPal Setup** in the drop down menu.

In the box marked PayPal Identity enter your PayPal ID (typically your email address).

In the PayPal Identity Token box paste your PayPal Identity Token.

Set your prices, and leave as zero's any time increments that you do not wish to offer. Press the Update button when done..

| Increment | Price |
|-----------|--------|
| 1 Hour | \$0.00 |
| 2 Hours | \$0.00 |
| 1 Day | \$0.00 |
| 3 Days | \$0.00 |
| 30 days | \$0.00 |
| 1 Year | \$0.00 |

There is a known issue with PayPal that can cause third party transactions with cents (i.e. \$1.99, or \$4.95) to sometimes process incorrectly. If you find some guest transactions are not processing try using whole dollar amounts (\$1.00, 4.00 etc.)

It would be a good idea at this point to run some sample charges through the system. You can refund those charges when you are done testing by using the PayPal merchant tools in your PayPal Account Management Screen.

The PayPal software module is provided to process credit card transactions securely through PayPal utilizing PayPal's systems. CheckBox Systems is not affiliated with PayPal and does not offer support for managing PayPal merchant accounts.

Free Access

The Free Access System allows you to give your guests free access two different ways:

You can allow free access once per period, for example 15 minutes free every day, or 1 day free per week. This is great for a coffee shop or restaurant that wants to advertise free internet access but prevent guests from taking up a table for hours upon hours. The guests will still get your welcome screen when they first log on, and if they qualify for free access (if they have not had free access already in the predefined period) then they will be invited to try the access for free. Once the free period has

expired the guest will be required to enter a valid ticket number or credit card (if you have those options enabled) and the free option will not be displayed for that guest.

| Access Time (when Button hit) | Trial Period (hide Button until) |
|--|-------------------------------------|
| <input checked="" type="radio"/> Disabled (removes Free Button) | <input type="radio"/> 30 Minutes |
| <input type="radio"/> 15 minutes | <input type="radio"/> 1 Hour |
| <input type="radio"/> 30 minutes | <input type="radio"/> 8 Hours |
| <input type="radio"/> 60 minutes | <input type="radio"/> 1 Day |
| <input type="radio"/> 2 hours | <input type="radio"/> 3 Days |
| <input type="radio"/> 8 hours | <input type="radio"/> 1 Week |
| <input type="radio"/> 1 Day | <input type="radio"/> 30 days |
| <input type="radio"/> 3 Days | |
| <input type="radio"/> 1 Week | |

Bandwidth Tier for Free Clients
 100% 50% 25%

If you wish to allow unrestricted free access to your customers, but still have the customers view your site welcome page, you can set the Trial Time and Trial Period time to be the same. For example; by setting the Trial Time and Trial Period both to 60 minutes, your clients will see the welcome page once every hour.

To enable Free Access, select

Access Controls in the top menu and then **Free Access Setup** on drop down.

Select the Trial Time, how much time you want to allow them on the system, and then select the **Trial Period**, the amount of time that must elapse before they get a new free trial.

Press **Update**.

You may also customize the message your users see by selecting **Customize Site** on the top menu and **Free Access Text** on the drop down hand menu and editing the message.

Bandwidth Tiers - You can set the amount of bandwidth that Free Access users receive relative to others (ticketed, PayPal and Permanent users). Bandwidth Tiers allow you to provide a basic level of service free to customers while providing other users a higher level of service. If you set the *Bandwidth Tier for Free Clients* to 100%, then users pushing the Free Access button will get the same amount of bandwidth as all other users. You can also select 50% or 25% bandwidth level, providing Free Access users 25% or 50% of the bandwidth other users get, as determined your setting under the Client Usage Policy setting.

PermaCode

PermaCodes are special Access Codes you can define yourself. Usage is similar to ticket numbers, but these codes are reusable by multiple guests at the same time. You may change PermaCodes at anytime, and any guest devices previously activated will still remain activated until the time set for their code has expired. PermaCodes are great for group events or special promotions and can save the need for printing and distributing large amounts of tickets for one time events.

You can have two different codes defined, with different amounts of access time assigned to each code.

To set up PermaCodes click on the **Access Controls** button on the top level menu, and then select the **PermaCode** button on the drop down menu.

Create your code word(s) and select the amount of time each code word is valid for and press update.

Guests now need to simply type the code into the box on the welcome page, and they will be let on-line for the amount of time assigned to each code.

PermaCodes can consist of letters and numbers, but not spaces or special characters. To make it easier for your guests PermaCodes are not case sensitive.

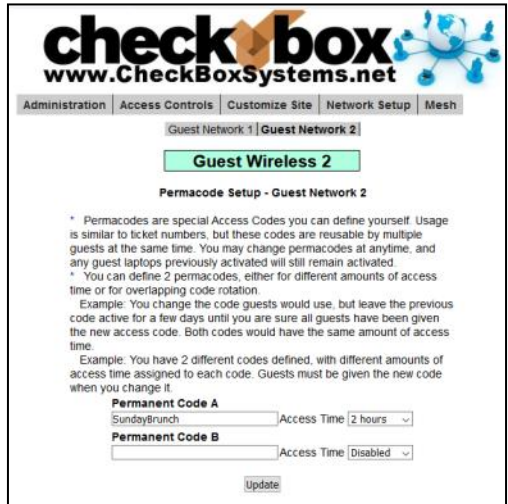

The screenshot shows the 'PermaCode Setup - Guest Network 2' page. At the top, there is a navigation bar with 'Administration', 'Access Controls', 'Customize Site', 'Network Setup', and 'Mesh'. Below this, there are tabs for 'Guest Network 1' and 'Guest Network 2', with 'Guest Network 2' selected. A green button labeled 'Guest Wireless 2' is visible. The main content area contains explanatory text and two sections for setting up codes:

- Permanent Code A**: SundayBrunch, Access Time: 2 hours
- Permanent Code B**: (empty field), Access Time: Disabled

An 'Update' button is located at the bottom of the form.

Room Prompt Setup

No matter if you use Free Access, Tickets or PayPal you can also require users to list their room, site or boat slip location using Room Prompt.



The screenshot shows the 'Guest Network Room Prompt Setup' page. At the top, there is a navigation bar with 'Administration', 'Access Controls', 'Customize Site', 'Network Setup', and 'Mesh'. Below this, there are tabs for 'Guest Network 1' and 'Guest Network 2', with 'Guest Network 1' selected. A blue button labeled 'Guest Wireless 1' is visible. The main content area contains explanatory text and options for enabling the room prompt:

- Enabling this option will add another selection to your customer login page. Clients will be required to fill in a value for this new selection.
- Entry field for Room/Pad numbers: Disabled, Enabled
- Field Header (prompt): Please Enter your room |

An 'update' button is located at the bottom of the form.

Selecting Room Prompt adds a second box to the welcome page that the guest must enter information into and the information entered will be listed on the Active Clients Screen next to the user.

To enable the Room Prompt, go to Customize Site then Room Prompt Setup. Select **Enabled** to turn on room prompts, and optionally you can change the text that appears above the prompt box.

Once Room prompts are enabled, in addition to clicking Free access, entering a ticket or PermaCode, users will be required to enter something into a second box, and the information that they enter will be listed in the Active Clients table.

Although your CheckBox can not validate any of the information provided by guests, the guests will be required to enter information, and if your staff sees invalid information listed under Active Clients (bogus room numbers or locations) they can simply disable the user.

check box
www.CheckBoxSystems.net

Administration | Access Controls | Customize Site | Network Setup | Mesh

Activated Hotspot clients

- * To Update a Client Remaining Time, click on the link in the Ticket column
- * To Update a Client Usage Policy, click on the link in the Policy column
- * Clients with a Policy highlighted in yellow are currently speed restricted
- * Clients with a Policy highlighted in red are currently blocked by abuse policy
- * Clients with a Policy highlighted in pink currently have P2P applications inhibited
- * Information in the Traffic column is in KiloBytes

Active Client Count: 2 Total Clients: 11

| Ticket | Time Left | Room | Traffic | Ip | Mac | AP | Sig | Policy |
|--------------|-----------|------|----------|----------------|-------------------|------------|-----|--------|
| vik | Permanent | 127 | 912865 | 192.168.17.208 | d8.31.cf.d0.54.ae | Front Desk | 51 | |
| front | Permanent | 127 | 2126821 | 192.168.17.46 | D0.67.E5.2D.2B.CB | | 0 | |
| samphone6 | Permanent | | 5460216 | Disconnected | 48.43.7C.C0.39.65 | | 0 | |
| pilgrimquest | 13.2 hrs | 126 | 150129 | Disconnected | 6C.29.95.BC.15.A1 | | 0 | |
| vick | Permanent | | 1431659 | Disconnected | 7C.C7.09.01.AA.61 | | 0 | |
| pilgrimquest | 8.2 hrs | 127 | 79589 | Disconnected | E0.06.E6.28.B2.23 | | 0 | |
| benphone | Permanent | | 758994 | Disconnected | 38.CA.DA.41.82.C7 | | 0 | |
| Pilgrimquest | Permanent | 104 | 955123 | Disconnected | DC.9B.9C.13.DD.E7 | | 0 | |
| Benipad | Permanent | | 84012517 | Disconnected | 34.51.C9.0E.E4.E1 | | 0 | |
| beniphone | Permanent | | 5217453 | Disconnected | 8C.58.77.25.39.87 | | 0 | |

Customizing your Welcome Screen

As you enable access methods the system will add the appropriate buttons and boxes to your welcome screen. You can customize the look of your welcome screen by uploading a picture or logo in .JPG format.



To upload an image click on **Customize Site** in the top menu and then select **Update Site Logo** on the drop down.

To change the message your guests see on the welcome page select **Customize Site** and then **Edit Logon Text** from the drop down menu. In this box you will see some html tags and then the default text. You can change the text to your own message, and if you are familiar with html you can customize fonts and colors with the html tags.

After your guests successfully login they will see a Welcome Message. If their ticket number is invalid they will see a Failed Login Message. These messages can also be customized by selecting the options in the drop down menu under **Customize Site**.

Tips for Uploading Graphics

CheckBox provides the option to upload a graphic for the welcome page and a different graphic that prints out on the tickets. Your guests will be accessing your CheckBox with devices that have different screen sizes. The graphic that you upload may look great on a desktop or laptop with a large screen, but be too large for a smartphone or tablet.

For best results these graphics should not be too large, either in pixels or file size. Pixels refers to the number of dots in a picture, these dots make up the picture itself. If a picture is described as 200 x 400 pixels, the picture is 200 dots wide by 400 dots tall. If the pixel count is too big then the picture may not fit on the page or it may push other elements of the page off the screen. It is important to remember that not all screens are the same size! It may look fine on your screen but may not fit on somebody else's screen!

File size refers to the amount of data used to record the picture information. Too little data and the picture looks coarse, blurry or grainy. Too much information and the picture takes too much space in storage and takes too long to download.

So what is the "right" size? For the welcome screen logo generally an image that is no bigger than 320 pixels wide and 120 pixels tall works best. You can make them less wide or less tall. As for file size, somewhere between 20Kb and 60Kb is about right. CheckBox will not accept graphic larger than 100Kb in size

For the Welcome Screen CheckBox can accept files in .jpg, .bmp and .gif format. Most devices can display all three formats.

For the logo on your ticket, an image that is 110 pixels tall by 200 pixels wide is ideal, with a file size around 20 kb.

There are many tools you can use to resize your graphic, including Adobe Photoshop, and shareware tools such as Irfanview (<http://www.irfanview.com>).

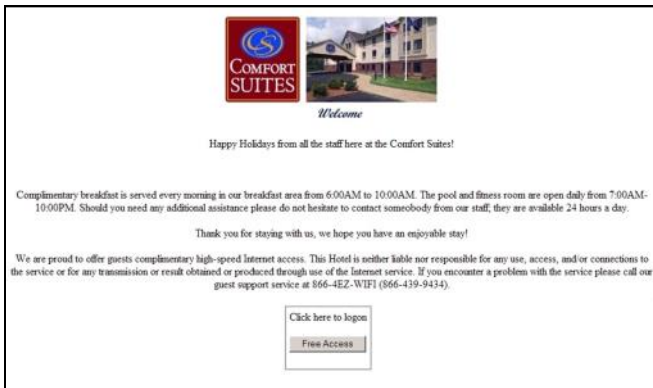

An example of a welcome screen

Accessing Your System from Outside The Hotspot But Inside Your Network

If you have your CheckBox connected to your company network you can access the Hotspot Administration Screens from any device on your network, even if these devices are not connected to the CheckBox system. In order to access your CheckBox from your office network or router you will need to know the WAN IP address assigned to the CheckBox by your network. If you have access to the Hotspot through a wireless client you can find this address in the Hotspot Administration Screen by clicking on **Network Setup**. In the section marked "Internet Connections" you will see the IP address listed immediately under eth3 for modems plugged into port 3, eth2 for modems plugged into port 2, and eth1 for modems plugged into port 1. This is the IP address assigned by your ISP or internal router to our system.

Once you have determined the IP address assigned to your CheckBox by your network you can access it by entering the IP address in the address bar of your web browser with **http://** in front of the address and **:3456/admin** after the address. For example, if the IP address assigned by your network to the CheckBox was 10.0.0.21 then you would enter **http://10.0.0.21:3456/admin**.

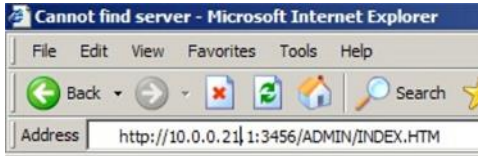

This will bring up a password login box just as it would if you were connected from inside the hotspot, and all administrative functions are accessible.

Accessing Your System From The Internet

There are two ways to access your CheckBox System remotely through the internet. The first way is to log in through the CheckBox Support System at www.checkboxsystems.net. There you will find a link to log into your CheckBox system from anywhere. The second way is to log on directly to your CheckBox via the system's IP address.

In order to access your CheckBox System through the CheckBox Support web site you will need a site number and user name. Please contact support@CheckBoxSystems.net to obtain your Site number and user name. CheckBox Support will respond with your remote ID and instruction on how to use it to access your system.

You can also access the CheckBox remotely by IP address, if your CheckBox is connected to your cable or DSL modem through a router, you will need to enable static routing, DMZ, or virtual servers through your router. *Please refer to your router manufacturer's instructions for details on how to enable static routing or virtual servers. Due to variations between different router models CheckBox support can not assist with making changes to your office router.*

In order to access your CheckBox from the internet, you need to know the IP address assigned to you by your internet service provider. An IP address is a unique number much like a telephone number that identifies a unique machine on the internet. No two IP addresses can be the same on the internet. Most ISP's use dynamic IP addresses which may change periodically, in order to conserve the pool of available IP addresses. Some ISP's will provide a static (non-changing) IP address upon request, and may charge for this service.

To access CheckBox through the internet you will enter the IP address assigned by your ISP in the address bar of your web browser with **http://** in front of the address and **:3456/admin** after the address. For example, if the static IP address for the CheckBox was 66.23.124.9 then you would enter **http:// 66.23.124.9:3456/admin**

This will then bring up a password login box just it would if you were connected from inside the hotspot, and all administrative functions are accessible.



Accessing Your System From Anywhere - An Easier Way

You can also access your system remotely using the Remote Access provided by the CheckBox Support Server. Accessing your system from the CheckBox Support Server does not require you to know or remember your IP address, and works no matter how often how often your IP address changes. This services is available at no charge for any system covered under the original warranty or an extended support agreement.

To access your CheckBox System remotely you will need your site ID number, user name and password. The site ID number is a four digit number assigned by CheckBox Support. Your user name is also assigned by CheckBox Support. Your remote access password is the same password that you use to access your CheckBox System when you are logging in directly to the CheckBox. If you do not have a site ID number and user name, please contact support@checkboxsystems.net to request one.

To Access your site via the Remote Access go to www.checkboxsystems.net and click on the **Login** on the top of the page.

In the Site Lookup box, enter your 4 digit site ID number then press **site lookup**.



A login box will pop up, requesting a username and password. (The actual box may look different depending upon your web browser). Enter your user name and password and press **OK**.

You will see a summary of your system status as last

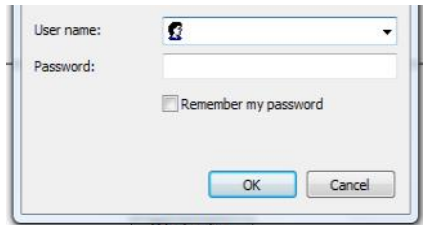

reported to the CheckBox support system. You are not yet in your local CheckBox.

Hotspots

| Location | Status | Version |
|----------------------------|--------|----------|
| Jims Place | 0:00 | 2.108MCw |
| Ethans Room | 0:00 | 2.108Sw |
| Peters House | 0:00 | 2.108Sw |
| mesh 4426 | 120:23 | 2.108Sw |

Typically your system status is updated every few hours. Any unit highlighted in green is working. Any item highlighted in yellow, pink or red is experiencing a malfunction. A unit highlighted in blue is currently undergoing a software update.

Click on the Name of your Site (the first item listed under **Location**) and you will be connected into your CheckBox System.

If you receive an error message after clicking on the name of your site then

your site is not accessible. Possible reasons for a site not being accessible include your CheckBox system being off-line (either the system is down or the internet connection to the system is not functioning) or the CheckBox system is behind a firewall.



Administering Active Clients

Under normal circumstances guests will get online, use their time and then automatically be logged off the system without any intervention from you or your staff. However there are options to manually adjust a guest's time remaining, delete a guest from the system, and manually add a guest.

By selecting **Administration** in the top menu and then **Active Clients** on the drop down menu you will see a list of all client computers currently ticketed. Client computers are listed by their MAC address, a unique electronic serial number assigned to each network adapter. You can see their time remaining and whether or not they are online. By clicking on their ticket number or time left you can manually add time or delete the client from the system. You can also rename the ticket to identify users or devices.

check box
www.CheckBoxSystems.net

Administration | Access Controls | Customize Site | Network Setup | Mesh

Activated Hotspot clients

- * To Update a Client Remaining Time, click on the link in the Ticket column
- * To Update a Client Usage Policy, click on the link in the Policy column
- * Clients with a Policy highlighted in yellow are currently speed restricted
- * Clients with a Policy highlighted in red are currently blocked by abuse policy
- Information in the Traffic column is in Kilobytes

| Ticket | Time Left | Traffic | Ip | Mac | AP | Sig | Policy |
|------------|-----------|----------------|-------------------|--------------------|----|-----|----------|
| Joe@Phone | Permanent | 168902 | Disconnected | 81.11.06.01.7b.2f | | 0 | 00000000 |
| Free | 10.3 hrs | 21702 | Disconnected | 0c.30.21.68.87.f1 | | 0 | 00000000 |
| Free | 10.5 hrs | 12350 | Disconnected | 10.a5.0b.17.44.5c | | 0 | 00000000 |
| ios@chrome | Permanent | 268632 | Disconnected | 1c.36.4c.20.d9.5b | | 0 | 00000000 |
| ios_phone | Permanent | 27258 | Disconnected | 89.7b.7a.7c.aa.71 | | 0 | 00000000 |
| ios@zoo | Permanent | 1125282 | Disconnected | 74.a5.43.3aa.ed.13 | | 0 | 00000000 |
| None | 0 | 192.168.17.118 | 28.57.67.39.b2.96 | Area2 | 24 | | 00000000 |

By selecting **All Clients** on the drop down menu you will see not only clients with tickets but also those clients that have connected with the hotspot system but who have not entered a ticket, credit card or free access. (Although these clients have been recognized by the system, they have not been allowed onto the internet yet, or have been on the internet and their time has expired.) These devices will be identified with a ticket number of "none". Here you can manually allow them online by clicking on that ticket number and selecting the amount of time you would like the client to be authorized for.

check box
www.CheckBoxSystems.net

Administration | Access Controls | Customize Site | Network Setup | Mesh

All Hotspot client systems

- * To update the remaining time, click on the link in the Ticket column
- * To manually activate a Client, click on the link in the Ticket column
- * Information in the Traffic column is in Kilobytes

| Ticket | Time Left | Traffic | Ip | Mac | AP | Sig |
|------------|-----------|----------------|-------------------|--------------------|----|-----|
| Joe@Phone | Permanent | 168902 | Disconnected | 81.11.06.01.7b.2f | | 0 |
| Free | 10.3 hrs | 21702 | Disconnected | 0c.30.21.68.87.f1 | | 0 |
| Free | 10.5 hrs | 12350 | Disconnected | 10.a5.0b.17.44.5c | | 0 |
| ios@chrome | Permanent | 268632 | Disconnected | 1c.36.4c.20.d9.5b | | 0 |
| ios_phone | Permanent | 27258 | Disconnected | 89.7b.7a.7c.aa.71 | | 0 |
| ios@zoo | Permanent | 1125282 | Disconnected | 74.a5.43.3aa.ed.13 | | 0 |
| None | 0 | 192.168.17.118 | 28.57.67.39.b2.96 | Area2 | 24 | |

The third column for each client lists how much data traffic they have put through the system. This information is in kilobytes, and is counted from the time they activate their ticket.

The last two columns list the access point or repeater that the client is connected to, and the strength of the signal that the system is receiving from the client. Generally the received signal strength of the client is roughly equal the signal that the client is receiving from the system. In most cases, signals greater than 12 to 15 should result in a good connection. These signals are 5 minute averages, and it is normal for these to fluctuate.

Labeling Users

For easy identification, you can change the label name for a user in the system. For example, if you have several computers in the office that are permanent clients, and some users that are employees with long term tickets, you can label them by their name.

To change the label of a user, simply click on their ticket number in the ticket column (If they used PayPal, Free Access or if you enabled them manually click on the PayPal transaction number, "Free", or "Manual" label in the ticket column). Enter the new label or name in the box marked "Identity" and press **update**. When entering a name or label, do not use spaces or special characters.

check box
www.CheckBoxSystems.net

Administration | Access Controls | Customize Site | Network Setup | Mesh

Update Client Status

Set or Update the remaining time for client 1c.39.4c.20.d9.5b

Set remaining client access time

Identity ios@chrome

Time Unchanged
 Disable Client
 Permanent Client

10 minutes
 20 minutes
 40 minutes

2 hours
 4 hours
 24 hours

2 days
 3 days
 5 days

7 days
 14 days
 30 days

60 days
 90 days
 120 days

180 days
 270 days
 1 year

Client Usage Policy

With the Client Usage Policy function, you can set how much bandwidth a guest can consume. Bandwidth is the amount of data a guest passes through the system. The system can only pass a finite amount of data at a time, with the limiting factor usually being the internet connection itself. Most internet connections such as cable or DSL typically pass between 3Mb to 2000Mb. Fiber can pass up to 1Gb of data, while satellite and T1 circuits can be slower than 1Mb. Some internet service providers, especially satellite based providers, have limits on how much data can be used per day or per month.

Most guests will never reach their bandwidth limits. However some guests may attempt to use the system for downloading large files, such as movies or video. This can cause excessive usage and negatively impact all of your guests. If you use satellite or if your ISP has a daily or monthly download limit, one guest could easily consume your entire allotment.

The Client Usage Policy is a system-wide rule that sets limits for all users of the system. It allows you to set an hourly limit on the amount of data each user can consume. Before reaching the limit each user will have full access to the bandwidth on the internet connection—the system will divide the available bandwidth evenly among the active users. When a user begins to approach their hourly limit that user will be reduced to a slower speed calculated to prevent them from exceeding the hourly limit you have set in the Client Usage Policy.

To set the Client Usage Policy select **Administration** on the top menu and then select **Client Usage Policy** on the drop down menu. Choose what type of Internet connection you have and then choose one of the preset Policies or you can choose custom and manually set a limit. In most cases the best choice is to select **Dynamic**. Dynamic will allow the system to automatically manage the bandwidth allotted to each guest based on how busy the system is and what the ISP is actually providing for bandwidth at the moment.

The last column in the Active Clients table

| Ticket | Time Left | Traffic | IP | Mac | Ap | Policy |
|---------------------|--------------|-----------|-----------------|-------------------|----------|--------|
| 1021-Silver | 1:42 d (day) | 412.25K | 102.188.117.202 | 74:43:56:01:99:88 | 102-020a | 20 |
| 1020-Silver | Permanent | 43062.41K | 102.188.117.102 | 10:40:32:26:07:48 | 102-0033 | 10 |
| 955-Orange | 1:31 d (day) | 33659.91K | 102.188.117.102 | 08:50:32:00:00:00 | 102-000e | 10 |
| 911-Silver | 1:52 d (day) | 20425.25K | 102.188.117.104 | 45:3a:28:00:00:00 | 102-000e | 20 |
| 732-Orange | 2:05 d (day) | 10250.00K | 102.188.117.102 | 47:70:38:00:00:00 | 102-020a | 20 |
| Private - Auto. 102 | Permanent | 0:04K | 102.188.117.102 | 26:36:03:00:00:00 | 102-000e | 20 |
| 642-White | 1:42 d (day) | 6947.94K | 102.188.117.92 | 34:aa:5b:55:00:00 | 102-020a | 20 |
| 613-White | 1:01 d (day) | 32142K | 102.188.117.68 | 24:01:77:00:00:00 | 102-000e | 10 |
| 734-Silver | 2:21 d (day) | 83881.4K | 102.188.117.68 | 18:4f:7c:00:00:00 | 102-020a | 20 |
| 1004101017 | 1:01 d (day) | 10222.00K | (Disconnected) | 12:18:17:00:00:00 | 102-000e | 10 |

Network Bandwidth Management Settings

Guest Network 1

Bandwidth Management

Guest Network 2

Bandwidth Management

Min Max

Customized Bandwidth Limits

Admin Network

Bandwidth Management

Customized Bandwidth Limits

@ MB per hour per client

shows the Usage Policy status of each individual active user. If the policy box is green, the user has full access to available bandwidth. If the policy box is yellow, the user is approaching the bandwidth limit set by the system and their speed has been reduced. The reduced speed will be displayed in the yellow box.

You can allow exceptions to the usage policy for certain users to allow them unrestricted bandwidth - this feature is particularly handy for your own computer or the office computers. To set up a user for unrestricted bandwidth,

simply click on the green or yellow policy box and a screen will open that allows you to select unrestricted usage. You only need to set unrestricted usage once per ticket, and the user will remain unrestricted until their ticket expires. If this is for an office computer consider setting a Permanent ticket by clicking on the ticket number and setting it to Permanent.

Usage status for:

Identity/Code: **Free**

Client Adapter: **0c:30:21:56:87:ff**

Recent download: **0%** of Policy

Recent upload: **0%** of Policy

Bandwidth Limiting: **None**

Active Connections: **Disconnected**

Automatically Managed

Unrestricted Usage

Network Statistics

You can track total data amounts consumed by your CheckBox System under Network Setup -> Statistics .

Here you can track both inbound and outbound data usage for your system for the past 30 days, and also see historical usage over the past twelve months.

Data highlighted in blue and marked **rx** is data that was downloaded from the Internet. Data highlighted in brown and marked **tx** is data that was uploaded to the Internet.

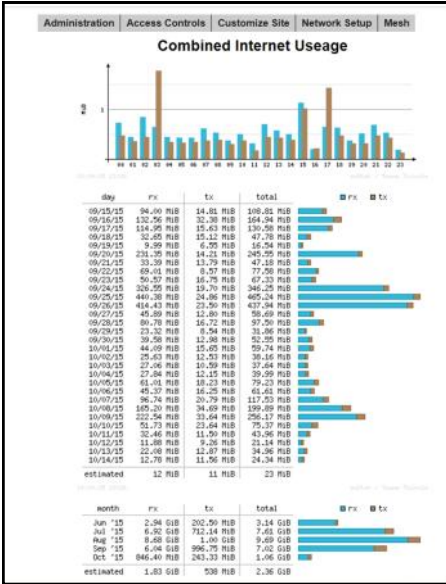

how your different Internet connections perform throughout the day.

By selecting the Hourly link at the bottom of the page you can view the total system usage for all of your modem connections combined.

You can also view usage for each Internet connection ("Adapter") on an hourly basis. This can help you see

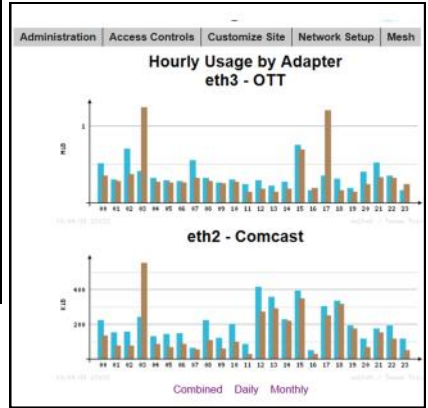

By selecting the Monthly link at the bottom of the page you can see a summary of the last thirty days of total system data usage.

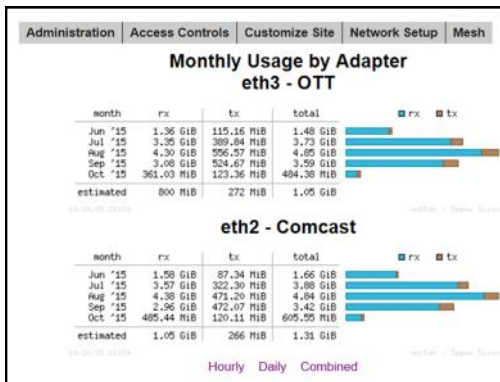

Signal Strength, Power Levels & Antennas

Communication between your guest's devices and the CheckBox is a two-way transaction, not a one-way transaction like a radio or TV broadcast is. For a successful connection not only does a signal need to get from the CheckBox to the user's device, but they need to get a signal back to the CheckBox. Portable WiFi devices are not all created equal and few have an external antenna. It is not unusual for a guest to "see" a signal of a few bars, or "good" but have a difficult time maintaining a connection. This is usually a case of the WiFi device seeing the signal from the CheckBox but the WiFi device does not have the strength to call back to the CheckBox.

Speaking of signals - signal strength displays are an approximation of the signal strength averaged over a period of time and do not take into account signal noise, the interference inherit in every radio transmission. Users may see a strong signal displayed, but due to noise and interference still not be able to establish a connection. The opposite can also occur; sometimes users will see a weak signal and still have a solid connection. Regardless of what the signal strength display reads the bottom line for the user is always this: Can they connect and is the connection fast enough?

One way to improve the range of the signal is by adding a long range antenna to your access point (the access point in this case is the CheckBox system). Long range antennas can sometimes help and sometimes can make the situation worse. While a standard antenna sends out radio waves equally in all directions like a balloon, long range antennas achieve greater range by changing the shape of the signal, flattening out the balloon into more of a donut, sending less of the signal straight up into the sky and more out towards the edges. These antennas can generally extend the usable range from 10% to 30%. However they can introduce two new problems; the case of the WiFi device seeing the CheckBox but the CheckBox not being able to WiFi device mentioned above, or a case where the "donut" is so flat that it shoots over the heads of the users.

A second type of antenna re-shapes the signal even more, sending it in a pinpoint beam. These antennas can increase range ten-fold or more, however if the user is not in the direct path of the signal they will not be able to see it. Even if they are in the direct path if they are usually not able to send a signal back the full distance and they will not be able to establish a connection. These high-gain point-to-point antennas are best used in pairs, one on each end of the path, and while not practical for guest WiFi devices they are good for connecting buildings in remote locations or repeaters in areas not contiguous to other units.

Another way to improve range is to increase transmit power. Since we do not have control over the quality of the user's devices we cannot affect their transmit power, but we could boost ours. CheckBox already uses the maximum legal power for unlicensed operation in the frequencies (channels) it occupies. There are WiFi "amplifiers" that can boost power, but these are not legal. Unlicensed operation at higher power can result in the property owner being fined.

When you boost the transmit power on one end of the connection but not the other you also run into the problem of one side being able to see the signal from the other side but not being able to send a signal back.

Since consumer WiFi devices do not have good antennas and do not generally use the maximum output power they really benefit from having a high density signal. The best way to have a high density signal is by using multiple access points.

Determining the proper number of access points requires taking into consideration several factors:

How much area do you need to cover? What are the surroundings? Are there walls or open spaces? Is the building made of wood, rebar reinforced concrete, or steel? Is there any

interference in the area?

On a flat open field with no interference a signal can travel up to 1000'. When we start adding walls, other devices and users, that distance will begin to shrink.

For example, a hotel with two wings each 200 feet long and three floors per wing, made of rebar reinforced concrete, might need 16 or more meshing access points to provide solid coverage. Another hotel, constructed of wood but with similar dimensions, may only need 8 meshing access points to provide coverage.

Another example would be a campground that is on an open flat field. To provide complete coverage however you need to penetrate the aluminum skin of the RVs coaches which might require meshing access points spaced every 200 feet, so that no RV is more than 100 feet from a unit.

If that hotel happens to be at the end of an airport runway with a radar system nearby or that campground has a cell tower in the middle of the property then interference from those devices may require additional units to overcome the interference.

Mesh Repeaters & Mesh Node Status Display

CheckBox meshing access points are self-configuring. As long as they can receive a signal from one of their peers or the they will establish a connection among themselves and actively determine the best route back to the unit.



These meshing access points can run as wired access points, connecting back to your CheckBox Controller with a wired connections, or as wireless meshing access points, connecting automatically back to the controller wirelessly. When run in a wireless mesh configuration the access points do need to be connected to a nearby power source. Performance in wireless meshing mode will depend upon the signal strength of the wireless signal received from the system as well as noise and wireless interference. Generally overall throughput will not be as good as if the access points were wired; wireless meshing works best in applications where running a connection back to the controller is not possible.

IMPORTANT: The first time a mesh repeater is added to the network it will show up highlighted in **blue** in the mesh status display. Until you click on this repeater to accept it into the system it can not service clients or pass traffic. You must click on blue units to allow them to join the system. This only needs to be done once, and after a unit has joined the system it will be remembered by the system, even after power failures or prolonged storage. Labeling the repeaters here makes it easier to remember where they are located.

Once your Mesh Repeaters are in place you can monitor their status by selecting **Mesh** on the top menu. You can check the status of your repeaters by clicking on the Mesh button on the top menu.

The first column identifies the repeater unit by it's MAC address, the electronic serial

number used to identify network devices.

The second column shows the units name or location; you can change this label by clicking in this box and entering a name or location. By default it is a row of "*****" You also will click on the row of "*****" the first time a repeater is added to a system to allow it into the mesh.



Administration | Access Controls | Customize Site | Network Setup | Mesh

Mesh Node Status

| Unit | Location | Connection | IP | Signal | Link | Chan | Chan | Clients |
|--------------|---------------------|---------------------|----------------|--------|------|------|------|---------|
| F09FC2197BB7 | Controller | | 192.168.17.1 | | | | | 0 |
| 44D1FA37B0D0 | A/P Arcade (AX4) | Controller | 192.168.17.215 | Wired | 1000 | 11 | 149 | 5 |
| 44D1FA37B11E | A/P Bathroom (AX/4) | Controller | 192.168.17.67 | Wired | 1000 | 11 | 149 | 7 |
| F09FC2A90CB4 | A/P Office (A/X2) | Controller | 192.168.17.192 | Wired | 1000 | 11 | 149 | 3 |
| 44D1FA925D33 | A/P Site #60 (A/X4) | Controller | 192.168.17.105 | Wired | 1000 | 11 | 149 | 10 |
| 44D1FA925ECE | A/P Site #70 (A/X4) | Controller | 192.168.17.24 | Wired | 1000 | 11 | 149 | 13 |
| F09FC2A6DEBC | Blacksmith (A/X2) | A/P Site #70 (A/X4) | 192.168.17.191 | 34 | 234 | 11 | 149 | 0 |
| 44D1FA37AA49 | Cabin #3 (A/X4) | A/P Bathroom (AX/4) | 192.168.17.43 | 51 | 650 | 11 | 149 | 1 |
| F09FC2A90D04 | Gameroom (A/X2) | A/P Bathroom (AX/4) | 192.168.17.35 | 67 | 866 | 11 | 149 | 2 |
| 44D1FA925F70 | Site #24 (A/X4) | A/P Arcade (AX4) | 192.168.17.207 | 60 | 526 | 11 | 149 | 1 |
| 44D1FA925E71 | Site #27 (A/X4) | A/P Arcade (AX4) | 192.168.17.135 | 57 | 526 | 11 | 149 | 2 |
| 44D1FA925F73 | Site #46 (A/X4) | A/P Arcade (AX4) | 192.168.17.210 | 57 | 650 | 11 | 149 | 4 |
| 44D1FA37AF50 | Site #53 (A/X4) | A/P Site #70 (A/X4) | 192.168.17.214 | 60 | 866 | 11 | 149 | 4 |
| 44D1FA925E5C | Site #77 (A/X4) | A/P Site #60 (A/X4) | 192.168.17.114 | 46 | 650 | 11 | 149 | 3 |

Associated Clients: 55

The third column shows the name or location of the unit from which this unit gets it's connection, this may be the CheckBox or another repeater if the units have daisy chained themselves. Mesh repeaters are constantly evaluating their connections and "talking" to other repeaters and the to determine the best route back to the and the internet. You may see this change occasionally as the system reconfigures itself to deal with changing conditions.

The fourth column shows the IP (network) address of the unit.

The fifth column shows the current signal strength of this unit to it's upstream connection. The signal strength is a 5 minute average, and it is normal for this to fluctuate. Any unit with a low signal strength will be highlighted in Yellow or Red. Units highlighted in yellow will have slower connections that will be unreliable. Units in Red are not able to support traffic or users as they have a very low or no connection (often as the result of issues with power or wiring at the unit). The signal is only displayed for access points running in wireless mode (access points without a wired Ethernet connection to the CheckBox), any wired units will display "wired" in this column.

The sixth column shows the Link speed, the maximum speed data can travel over this link. Other factors may cause actual throughput to be lower.

The seventh column indicates what channel the access point is operating on. Systems with multiple wired access points can change the channel of each wired access point by clicking on the unit name and adjusting the preferred channel accordingly.

The last column shows how many clients are using this access point.

Final Installation Checklist

After you have completed installing your system use this checklist to make sure everything is ready for your guests.

Physical Installation - CheckBox

- CheckBox Controller unit is connected to power.
- CheckBox Controller unit is connected to internet connection.
- Network cables are not stapled to walls or cable tied to AC wiring or power lines.

Physical Installation - Access Points

- Access points are connected to power.
- [Outdoor units only] Access points are mounted at least 20 feet off of the ground.
- Access points are mounted at least 4 feet away from other antennas.
- Serial number of each repeater is noted for labeling by location in mesh display.

System Setup - CheckBox Controller

- Set administrative password.
- Accept access points into network on the Mesh page.
- Upload your graphic for Welcome Screen and Tickets.
- Set up your Welcome Message.
- Change SSID in Network Setup.
- Print out user tickets [for systems using tickets].
- Set up Free Access [for systems using free access].
- Set up PayPal credit card system [for systems using PayPal].

CheckBox S/A/F/E - Survey and Feedback Engine

CheckBox includes the S/A/F/E Survey and Feedback Engine, a system to provide direct and ongoing communications with your guests to increase guest satisfaction.

With CheckBox S/A/F/E - The CheckBox Survey and Feedback Engine - your WiFi does more than just connect your guests to the Internet. S/A/F/E let's you reach your guests - and your guests reach you - instantly and easily via any connected device to increase customer service and guest satisfaction.

With the CheckBox Survey and Feedback Engine as soon as your guests log onto your Wi-Fi your CheckBox automatically sends a welcome message via email or text. This welcome message includes any information that you want your guests to know and they can reply to the message to ask you or your staff questions, make requests or to let you know about any issues that need to be addressed.

The CheckBox Survey and Feedback Engine routes messages between you and your guests to any desktop or portable devices you designate, allowing easy and quick follow up - a great way to save time while increasing guest satisfaction and engagement.

Guests can get their questions answered quickly without trekking to the office or hunting for a staff member, and staff can handle guests issues quicker with less interruption of other tasks.

CheckBox S/A/F/E is available to all CheckBox Customers at no additional cost.

CheckBox S/A/F/E is another feature included at no additional charge to all CheckBox customers on a current support plan or under their original warranty.

The conversation doesn't stop when your guests disconnect from your WiFi or leave your property.

CheckBox detects when your guest has left the property, and after a predetermined interval can automatically send a follow up message you design thanking them for their stay and inviting them back. With the built in survey tools you can send a follow up survey to gather feedback and send follow up messages to invite them to return.



Setting up CheckBox S/A/F/E

To set up your S/A/F/E you will need to have your Remote Site Login ID number, your username and password. If you do not have these or have forgotten your them please contact Support@CheckBoxSystems.net to set these up.

Login to your CheckBox management screens and navigate to Customize Site then Survey and Feedback Setup.

In the area labelled Entry Field for Survey Contact Info click on the button marked Enabled to turn on the S/A/F/E feature.

The CheckBox Welcome page will now have a field where guests can enter either their email address or mobile phone number for texting. You can make it either optional or mandatory to enter the address or mobile number.

In the field header prompt you can customize the message the guest sees when asked for their email or mobile number.

Your guest log in screen will have this area added where your guest then share their email address or mobile number.

Your actual login screen will look different depending upon the graphics you have added and other options you have enabled.



The screenshot shows the CheckBox Systems management interface. At the top, there is a navigation menu with the following items: Administration, Access Controls, Customize Site, Network Setup, and Mesh. Below this menu, a list of configuration options is displayed. The option 'Survey and Feedback Setup' is highlighted in yellow. Other options include 'Show Current Login', 'Edit Login Text', 'Show Welcome', 'Edit Welcome Text', 'Show Failed Login', 'Edit Failed Login', 'Show Abuse Screen', 'Edit Abuse Screen', 'Room Prompt Setup', 'Free Access Setup', 'Free Access Text', 'Update Site Logo', and 'Update Ticket Logo'.



The screenshot shows the 'CheckBox S/A/F/E Setup' configuration page. The page title is 'CheckBox S/A/F/E Setup' and the subtitle is 'CheckBox Survey and Feedback Engine'. Below the title, there is a section titled 'To enable Survey and Feedback, First click on the button below to set up your survey parameters on the survey portal. Then return to this page and complete the setup below.' This section contains a 'Setup Survey Parameters' button. Below this, there is a section titled 'Enabling this option will add another selection to your customer login page. Clients will be asked to include an email address or text message number for survey and feedback.' This section contains three radio button options: 'Entry field for survey contact info' with sub-options 'Disabled', 'Enabled' (selected), and 'Optional', and 'Field Header (prompt)' with sub-options 'Required' (selected) and 'Optional'. Below these options is a text input field with the placeholder text 'Please share your contact info' and a dropdown menu with the selected option '- either mobile number or email address -'. An 'Update' button is located below the input field. At the bottom of the page, there is a note: 'Enabling this option will add another entry field to the Hotspot login page Users will be prompted to'.

Use of this service constitutes agreement with the Terms of Service listed below. If you do not agree with the Terms of Service you may not use this service.

Use of this service shall be for lawful purposes only. Users consuming excessive bandwidth will be automatically subjected to reduced speeds. Abuse of this service

**Please share your contact info
- either mobile number or email address -
with us to help us better serve you.
We will not share or sell your information.**

Click Here for 15 minutes of Free Access

Free Access



Next we need to setup the welcome messages and optionally the surveys.

Click on the Setup Survey Parameters button.

Login here with your Site number, Username and password.

This portal can also be used to remotely log in from anywhere to manage both your CheckBox Guest WiFi and your S/A/F/E Systems and can be reached directly by going to

<https://portal.checkboxsystems.net>



Once logged in you will first see a summary of your system status. You will see the name of your property, the names of your access points, and the status of your system. Any device highlighted in red is having issues and is not online.

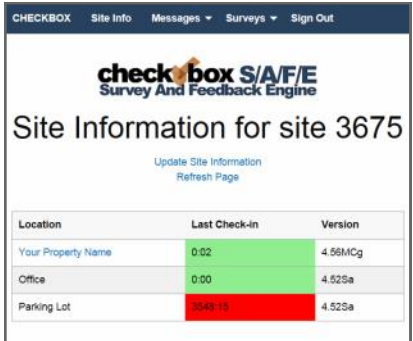

Navigate to Surveys and then Survey and Message Settings .

Here you will put in an address where messages from guests will be sent to. This should be an address that is monitored by staff or management to provide timely responses to guest issues.



The Send Survey After drop down setting is where you set a delay for when the system no longer detects the guest on property after which time a survey can be sent to the guest for follow up.

Next navigate to Messages and then My Messages. Here you will set up the welcome message that is emailed or texted to every user.

Here you can add new messages to be sent and see a summary of all messages that you have already created and are available to choose from.

Click on the Add New Message button.

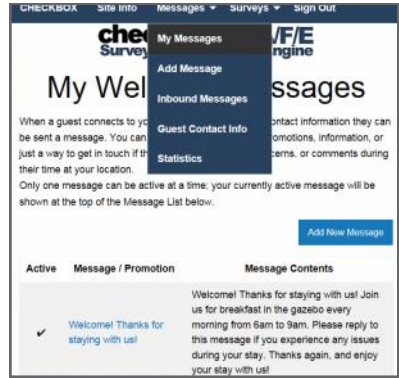

On this page you will create the welcome messages emailed or texted to your guests when the first connect to your CheckBox.

You can create multiple messages and save them, but only one message at a time can be active.

Since guests have the option of supplying an email address or a text address we have to format the message two different ways to accommodate the different formatting of the two types of messages we may be sending.



The Welcome Message Title / Email Subject box is the subject line of emails sent.

The Text Message Content box is where you enter the text message that will be sent. Text messages are limited to 140 characters total, including spaces, so messages must be short and sweet.

The Email Message Content is where you enter the message sent to email users. You have more room here and can add more information as appropriate.

To the right of the Welcome Message Title line is a box you can toggle to make the message active or not. You can create and save multiple messages, however only one can be active at a time. You can also choose to have none active and no message sent.

At this point your welcome message has been set up, and your guests can reply to your welcome message to ask questions or notify you of issues, and you can reply to those message - providing a convenient two-way messaging platform for you and your guests.

Receiving & Responding to Messages w/ S/A/F/E

If a guest replies to their welcome message that reply will be sent to the management email address you entered in the Survey & Message Settings screen and will be forwarded to your email inbox. Regardless of whether or not the guest is using texting or email, all messages will be automatically consolidated and sent to your email box.

From your email box you can reply to guest emails directly.

How late is the fitness center open?



If the message from the guest originated as a text messaging there will be a link in your email to click on to reply to the guest message. This link will take you directly to the guest's message in the CheckBox Portal.

You can also read and reply to text messages from your portal page. The most recent messages will be listed at the top of the list, and just click respond to reply.

Site Info Messages Surveys Sign Out

checkbox S/A/F/E
Survey And Feedback Engine

SMS Messages Received

| Message From | Received | Mobile Registered in | Message | Last Visited | Action |
|--------------|-----------------|----------------------|-----------------|--|---------|
| 8 | 11 Apr at 04:24 | CA US | I s | 8 Apr at 04:20 - Sunbeam Lake RV Resort x86 | Respond |
| 2 | 11 Mar at 16:03 | BC CA | He off | 10 Mar at 15:38 - Sunbeam Lake RV Resort x86 | Respond |
| 5 | 9 Mar at 03:08 | CA US | Wh | 7 Mar at 22:12 - Sunbeam Lake RV Resort x86 | Respond |
| 9 | 7 Mar at 17:56 | BC CA | Ne | 7 Mar at 17:51 - Sunbeam Lake RV Resort x86 | Respond |
| 1 | 3 Feb at 22:32 | CA US | The re message. | 2 Feb at 20:59 - Sunbeam Lake RV Resort x86 | Respond |

Is there any pizza delivery nearby?



Creating Guest Surveys with S/A/F/E

You can use S/A/F/E to automatically send out a survey to your guests after they have left your property. CheckBox will monitor the guest's connection, and when they have disconnected from the network after a waiting pre-determined interval they survey can be automatically sent. This interval is set under Surveys -> Survey & Message Settings.

After the system has determined the guest has been off of the network for the predetermined time an email or text message will be sent inviting the guest to click a link to take your survey.

To create a survey navigate to Surveys -> Add Survey.

You can create and save multiple surveys, but only one survey can be active at a time.

Give your survey a title and create a message to go above your survey.

Survey questions can either be formatted so the responses are either a rating (1 through 5) or a comment field. Create your survey questions. Here you can also choose if this survey is currently active or not.

After you save the survey you can return to edit the questions if needed.

To see a list of the surveys you have created and to review the responses you have received navigate to Surveys -> My Surveys.

There you will see a list of all of your surveys and which one is active, and you can view the responses received by clicking on the View links on the right hand side.

| Active | Survey Title | Text / Notes | Sent Emails | Sent SMS | Responses Received |
|-------------------------------------|--|---|-------------|----------|------------------------|
| <input checked="" type="checkbox"/> | Thanks for staying at Lake RV Resort! | Thanks for staying at Lake RV Resort, we really appreciate you staying with us! Please take a moment and answer a couple of quick questions to help us improve or resort. | 2 | 0 | View 1 |
| <input type="checkbox"/> | Exit Survey | Please let us know how well the CheckBox WiFi worked for you. | 1 | 1 | View 2 |
| <input type="checkbox"/> | Thanks for staying with us at Lake Resort! | Thanks for staying with us at Lake Resort, we are glad you chose us. If you have a moment we would really appreciate your feedback to help us | 0 | 0 | |

S/A/F/E Guest Contact Information

You can view and download the contact information for your guest by going to Messages -> Guest Contact Info.

Here you find a list of when the guest first and last connected to your CheckBox and their email or mobile number.

You can download this information to use in a spreadsheet or marketing program by clicking on the Export Customer Details button. The information will be downloaded as a .CSV file.

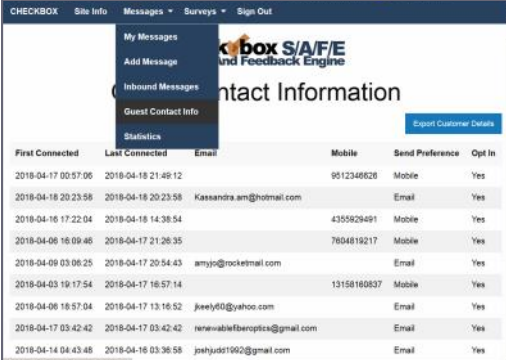

| First Connected | Last Connected | Email | Mobile | Send Preference | Opt In |
|---------------------|---------------------|--------------------------------|-------------|-----------------|--------|
| 2018-04-17 00:57:06 | 2018-04-18 21:49:12 | | 9512346626 | Mobile | Yes |
| 2018-04-18 20:23:58 | 2018-04-18 20:23:58 | Kassandra.am@hotmail.com | | Email | Yes |
| 2018-04-16 17:22:04 | 2018-04-18 14:38:54 | | 4355829491 | Mobile | Yes |
| 2018-04-08 16:09:46 | 2018-04-17 21:26:35 | | 7604819217 | Mobile | Yes |
| 2018-04-09 03:06:25 | 2018-04-17 20:54:43 | amyjo@rocketmail.com | | Email | Yes |
| 2018-04-03 19:17:54 | 2018-04-17 16:57:14 | | 13158160837 | Mobile | Yes |
| 2018-04-08 16:57:04 | 2018-04-17 13:16:52 | jjeely6@yahoo.com | | Email | Yes |
| 2018-04-17 03:42:42 | 2018-04-17 03:42:42 | rene@ablefiberoptics@gmail.com | | Email | Yes |
| 2018-04-14 04:43:48 | 2018-04-16 03:36:58 | jshjudd1992@gmail.com | | Email | Yes |

System Alerts

You can receive an email or text message if your CheckBox controller, one of your repeaters, or your internet connection goes off-line. These System Alerts are issued by the CheckBox Support Server, which monitors your system. This monitoring service is included in the first year warranty that comes with every CheckBox System, and is also included in the Extended Warranty Program.



Before you can set up alerts you will need a Remote Site log-in. If you do not have a remote site log-in you can request one from CheckBox by sending an email to support@checkboxsystems.net.

To set up alerts for your CheckBox;

1. Log in to the CheckBox support portal.
2. After logging into the support site click on "Site Info" and then the "Update Site Information" link in the middle of the screen.
3. Set your Alerts to either Aggressive, Normal or Relaxed (or you can disable alerts).
4. Enter the email address you want the alerts sent to.
5. Click the "Update Site Information" button.

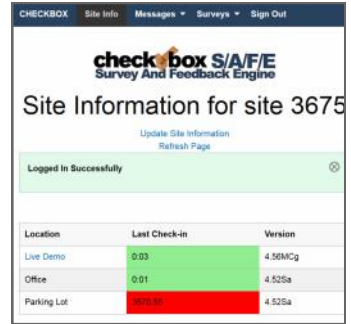

The first time you activate the alerts for your CheckBox system, the support system will need to download some configuration updates to your CheckBox units, which may take up to 4 hours to complete.

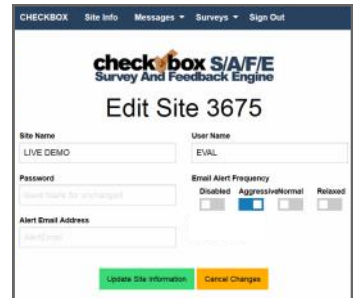

Setting alerts to Aggressive will generate an alert if a CheckBox mesh node or a controller unit is late for any of its scheduled check in cycles. This may cause an excessive amount of alerts to be generated if your system is on a slow or unreliable Internet connection (such as satellite or older DSL). It is not uncommon for a unit to be late or to miss a check in cycle due to network congestion or high traffic.

Setting alerts to Normal will generate an alert if a CheckBox mesh node or a controller unit two check in cycles. This is the setting most users will want.

Setting alerts to Relaxed will generate an email if a CheckBox mesh node or a controller unit fails to check in with the support server after four scheduled check in cycles. This setting is suitable for users with frequent power issues or issues with their internet service provider.

Many cell phone providers allow you to receive emails as text messages. If you wish to have the alerts sent to your cell phone as a text message, check with your cell phone provider as to the address format to use (often it looks something like yourphonenumber@cellphoneprovider.net) Some cell phone providers charge for incoming text messages. You may be charged by your cell phone provider to receive these messages.

Included and Optional Services

Included Warranty and Extended Warranty Support

Your CheckBox System includes a one year warranty from the date of purchase. This warranty includes:

- A hardware warranty with advanced exchange replacement
- Phone and email support for property management and staff
- Automatic software updates
- Access to the remote management portal
- Automatic email/text alerts of system outages
- S/A/F/E - the Survey and Feedback system

This warranty can be extended and renewed each year to provide ongoing coverage. Approximately two months before the end of your initial warranty and support period you will receive information on extending your warranty and support.

Guest Support

- ✓ 24/7 live support for guests and end users
- ✓ Dedicated toll free number
- ✓ Tracking of support incidents and escalation
- ✓ Can be used seasonally - no long term contract required.

Guest support is provided 24/7 by professional support staff at a dedicated support number. Support staff are available to assist guests connecting to the wireless service, configuring their wireless settings and logging on. Support staff have instant, real-time access to systems, can perform diagnostics, and when appropriate restart networks and alert property owners to issues, as well as escalating critical system issues to advanced technical support.

Guest support is priced on a per-room/per-campsite/per-boat-slip basis per month. *For more information or to order these services please contact CheckBox Support or your reseller.*

| Support Options Comparison | Hardware Warranty & Standard Support | Guest Support |
|---------------------------------|--|--|
| Support for Staff & Management | Yes | Yes |
| Support for Guests | No | Yes |
| Hours of Availability (Eastern) | 9am to 7pm, Eastern Mon—Fri | 24/7/365 |
| Cost | First year included free. Can be extended after the first year, annual fee applies, varies by system size. | \$1.50 per guest unit (requires Hardware Warranty & Support if not under original warranty) |

The following notice discloses the CheckBox Personal Data Collection and Handling policies.

CheckBox Systems LLC (hereafter referred to as CheckBox) is a provider of hardware and service solutions for certain sectors of businesses operating exclusively in the United States and U.S. territories.

During the course of normal business actively CheckBox or its agents on behalf of CheckBox may receive information from or about individuals, including but not limited to names, addresses and other contact information.

CheckBox may use the information it has received to market products services to current and prospective clients.

CheckBox may use the information it has received to provide services to clients or to client's customers on behalf clients.

CheckBox will not provide or share this information to any individual or organization outside of our business partner's and will only do so for use as needed to provide services to our clients and to market to potential clients. CheckBox does not sell any client information and does not share information outside of normal business operations (unless compelled by law).

Individuals wishing to have CheckBox remove their information should submit their request in writing to Support@CheckBoxSystems.net or submit their request in writing to the address on the bottom of this website.

The following notice discloses the privacy policy for the CheckBox Survey And Feedback Engine service.

CheckBox Systems LLC and its partners (hereafter collectively referred to as CheckBox) provide an optional service to its' clients known as the CheckBox Survey And Feedback Engine (hereafter referred to as SAFE or S/A/F/E).

CheckBox clients can opt to use SAFE to collect certain information, specifically email and/or mobile telephone numbers, at the request of and solely for use by our clients. Clients or their designated employees or agents may activate the SAFE service by selecting options inside of their CheckBox system that begin the collection process.

CheckBox will only collect information that is voluntarily provided by client's guests via the SAFE portal on the CheckBox WIFI system.

CheckBox employs industry standard best practices to protect this information both online and offline. The servers storing personally identifiable information are maintained in a secure environment.

In addition to technical protections only CheckBox employees who need access to the information to perform job specific tasks are granted access to guest information.

CheckBox claims neither ownership over this information nor makes any claim as to the validity of the information provided by client's guests. CheckBox will not provide, sell or rent this information to anyone outside of the client property (unless compelled by law). This information is only available to the client property that owns or operates the CheckBox System from which the information was collected. This information is only available via the CheckBox portal and the client or their designated employees or agents must initiate retrieval of this information via the CheckBox portal. CheckBox employees and agents are not allowed to furnish this information directly.

It is at the discretion of the client property that receives this information how to use it. It is the responsibility of the client property that receives this information to use it in accordance with applicable laws.

The following notice discloses what information CheckBox collects and tracks on individuals during data sessions using services provided by CheckBox Systems:

CheckBox Systems LLC (hereafter referred to as CheckBox) is a provider of hardware and service solutions for organizations to provide Internet connectivity to the public, typically, but not exclusively via WiFi.

CheckBox is designed to limit access to authorized users, limit data consumption and limited access to peer-to-peer file sharing services. Some or all of these features may be enabled or disabled by the property as the property sees fit for their needs.

In order to accomplish the above objectives CheckBox validates users by methods selected by the property that may or may not include disclosure of personal information and tracks user's device data consumption for the duration of the session. CheckBox does not store or record URLs, IP addresses accessed, or data sent or received by the user device.

CheckBox does not collect or store any user data from these sessions beyond the duration of the data session.

Properties may opt to use additional hardware from other vendors that filters, tracks or restrict access to certain URLs or IP addresses. Websites, apps or other service accessed by users may also track or otherwise record activity. End users assume responsibility for the security of their data and devices.

Revised 8/26/2021

These policies are subject to change.

Your Suggestions are Welcome

Many of the added features, improvements and refinements have been made at the suggestion of our users. We absolutely welcome your feedback and suggestions.

Warranties and Service

We have worked hard to design the best possible system for you and your guests. We want you be completely satisfied with your system. If you are not completely satisfied please let us know and we will try to make it right. If you are still not satisfied you may return the system in it's original condition within 30 days from the date of purchase for a full refund, less shipping and installation.

This system includes a one year warranty from the date of purchase and one year of standard support. This warranty covers repair or replacement of the components of the system as we determine necessary. The warranty does not cover damage due to improper installation, use of unauthorized accessories (including, but not limited to external antennas and power amplifiers) lightning, vandalism or physical abuse. Standard support is for use by the site management and employees and is provided via telephone or email at our option delivered during standard business hours. Standard support does not include guest support, on-site visits, after hours calls, or assistance with other network issues and items not related to this system. In no event shall CheckBox Systems be responsible for consequential damages due to the failure of this system or any of it's components. We reserve the right to terminate support in the unlikely event of excessive, or abusive calls. Under no circumstances will CheckBox Systems LLC liabilities exceed the original purchase price of the product. This is a network access device, and the end user is ultimately responsible for network and data security.

System builds 4.20 & higher

CheckBox Systems, Copyright 2022